

Highlights:

- Innovative & unique design
- Countless mounting possibilities
- AWX5™ waterproof connector
- Wide opening angle
- Outdoor rated construction
- Multi-tapping 70V / 100V line transformer

Product information:

"Don't feel like hanging around?"

The ALTI6M is a variant of the ALTI pendant speakers, featuring a die-cast mounting bracket for wall & ceiling mount purposes. This allows the same audio system design and identity throughout the entire installation in case some areas are not allowing pendant solutions being used due to the ceiling heights or structures. Acoustics and construction are identically crafted, while connections are made through weatherproof AWX5™ connectors, this construction has an IP65 rating.

The ALTI6M features a 2-way 6,5" driver combination with a coaxially mounted 1" soft dome tweeter and is fitted with a phase plug for excellent off-axis performance. The 2-way combination with a high-quality polypropylene enclosure and acoustic engineering craftsmanship guarantees premium performance for demanding applications. A continuous power handling of 60 Watt (RMS) and maximum power handling of 120 Watt is achieved.

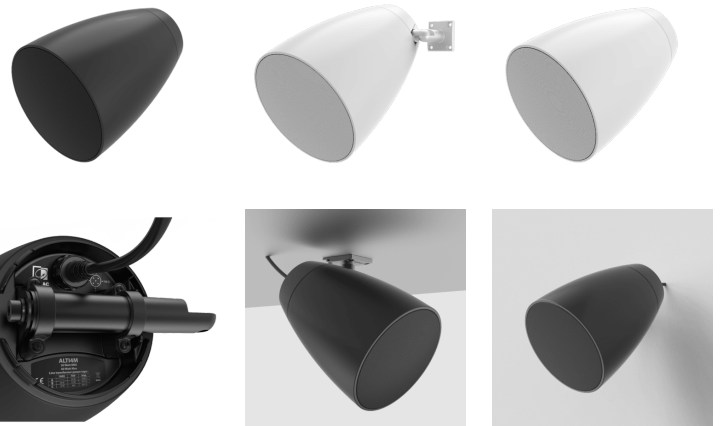

Certification:



Properties:

 Weatherproof

Impedance:

Ω 16 Ohm

Voltage:

 70-100 Volt

System specifications:

Speaker type		2-way coaxial
Peak power handling		240 W
Program power handling		120 W
RMS/AES power handling		60 W
Impedance		16 Ω
Line Transformer Tappings	1	83 Ω - 100 V / Not used - 70 V / 60 W
	2	167 Ω - 100 V / 60 W - 70 V / 30 W
	3	333 Ω - 100 V / 30 W - 70 V / 15 W
	4	667 Ω - 100 V / 15 W - 70 V / 7.5 W
Dispersion	Conical	115° (average 500 Hz to 5 kHz @ -6 dB)
Connectors		Waterproof AWX-5 connector
Sensitivity (1W/1m)		83 dB
Sound Pressure (Max. W/1m)	@ 16 Ω	101 dB
Frequency	Range (-10 dB)	61.5 Hz - 20 kHz
	Response (\pm 3 dB)	75 Hz - 17 kHz
Ingress Protection rating		IP65

Product Features:

Connection cable length	0.7 m	
Construction	Polypropylene	
Front finish	Aluminium grill	
Mounting & handling	2-way Revolving mounting bracket	
Weight	3.48 kg	
Dimensions	235 x 230 x 336 mm (W x H x D)	
Accessories	Included	5-pin connection cable (70 cm) AWC07
		2-way Revolving mounting bracket

Variants:

- ALTI6M/B - Black version
- ALTI6M/W - White version

Architects' and Engineers' Specifications:

This loudspeaker shall be a 2-way coaxial type featuring a 6" driver and a 1" soft dome tweeter and fitted with a line transformer allowing it to be used on both low impedance (16 Ohm) and 70/100 Volt distributed lines.

It shall have an RMS power handling of 60 Watt with a maximum power handling of 120 Watt and the frequency response ($\pm 3\text{dB}$) shall range from 75 Hz to 17 kHz. The sensitivity shall be at least 83 dB when measuring with an input signal of 1 Watt at a distance of 1 meter, while the maximum continuous sound pressure level at 100 V shall be 101 dB. The nominal dispersion shall be a 115° conical coverage pattern at -6dB (average 500Hz - 5kHz).

The loudspeaker shall have an impedance of 16 Ohm and shall be fitted with a multi-tapping line transformer with tappings for 24 Watt, 12 Watt, 6 Watt and 3 Watt including a 16 Ohm bypass. Selection of the power taps shall be done using a rotary switch located under the cable cover.

The speaker frame shall be constructed in high quality Polypropylene material which comes available in black and white. A weatherproof AWX5™ connection must be used, which gives the speaker an IP65 rating. Mounting the loudspeaker shall be done with the die-cast 2-way revolving mounting bracket.

The loudspeaker shall have a diameter of 230 mm, a height of 302 mm and the weight shall not exceed 4kg.

Acoustical data graphs:

Horizontal Polars:

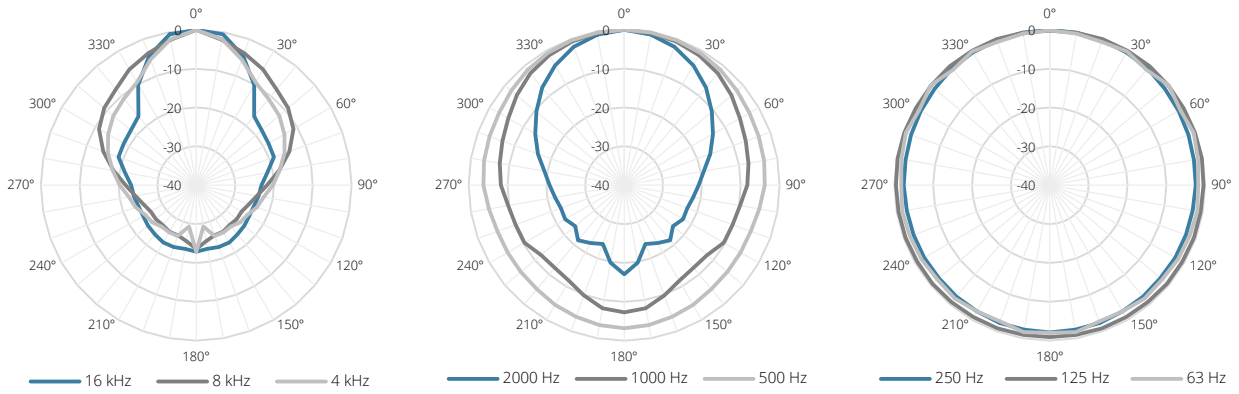

Vertical Polars:

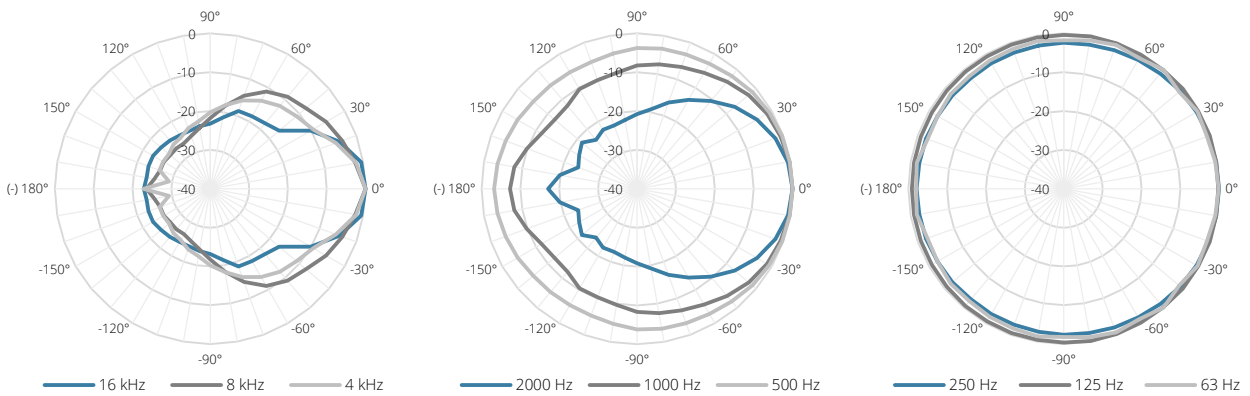

Sensitivity:

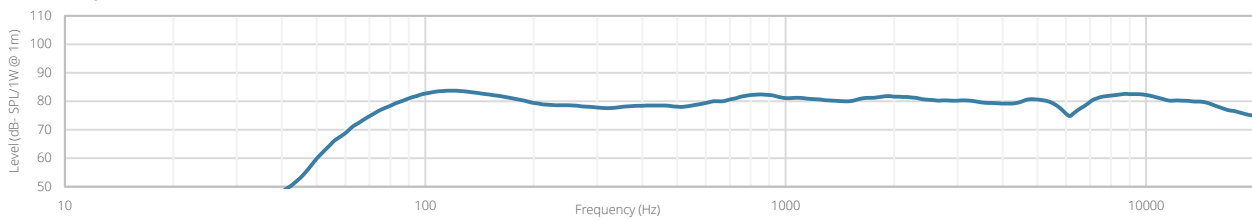

Beamwidth (-3dB):

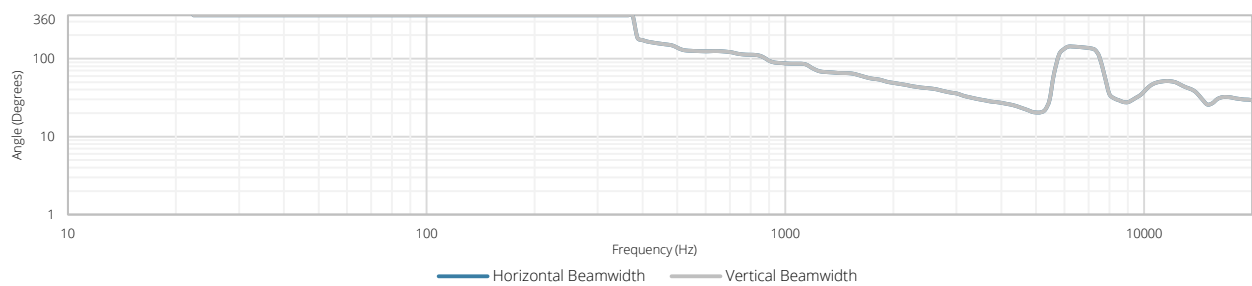

Directivity index:

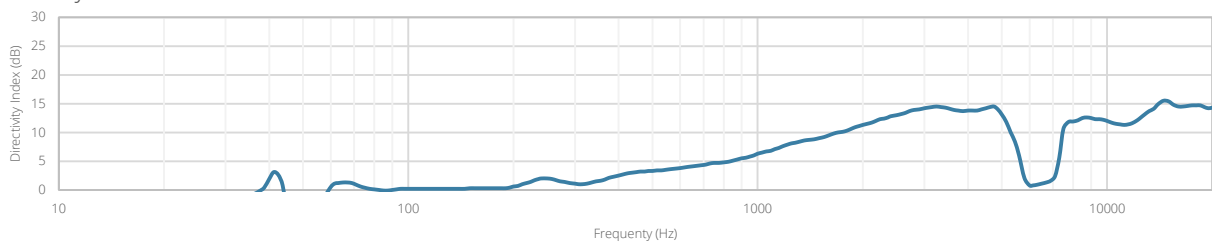

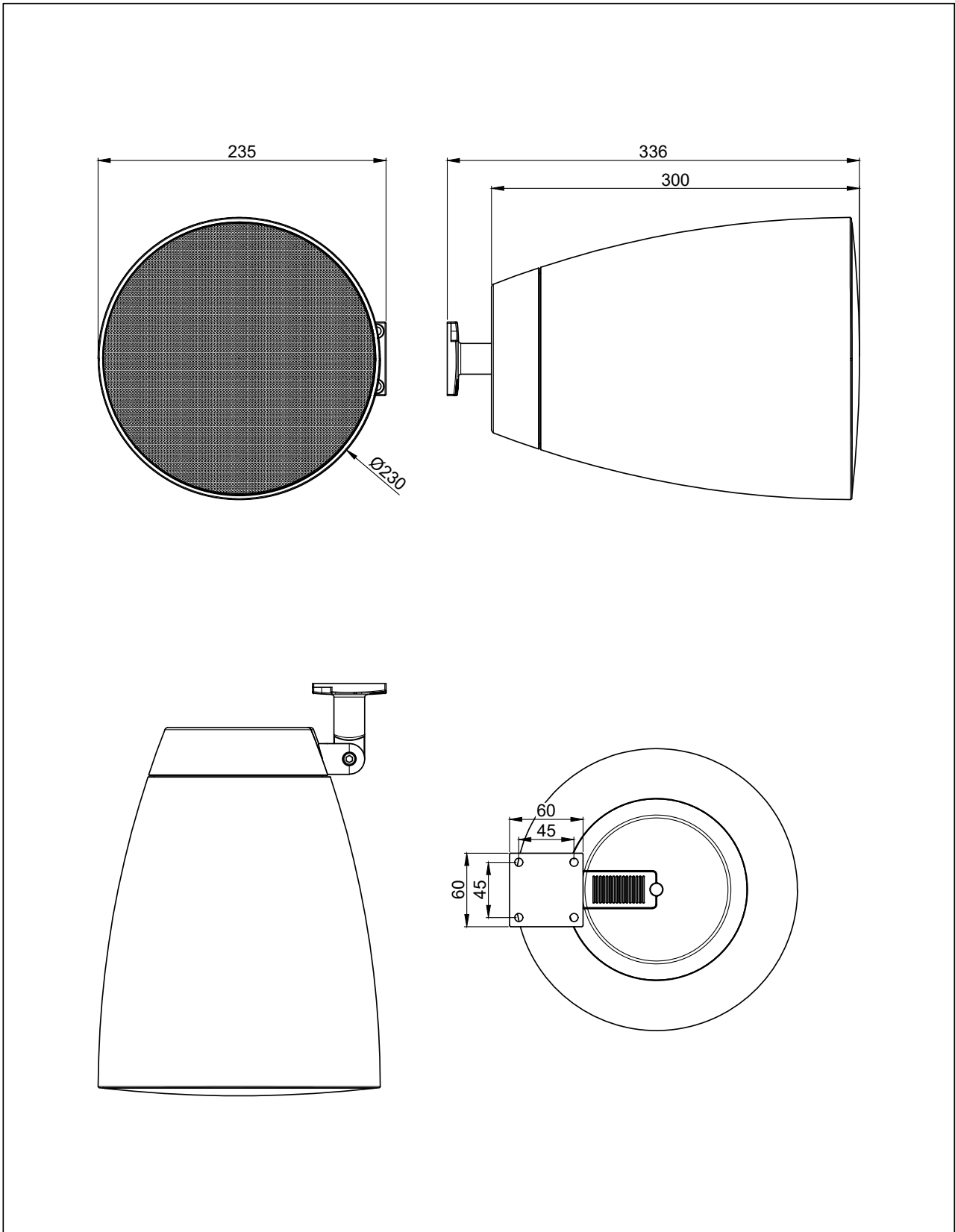

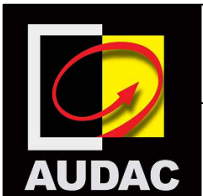
	ALTI6M		Product description: 2-WAY 6.5" PROJECTOR SPEAKER 60W - 70V/100V & 16 OHM
	Weight: 4,12 kg	Outer dimensions: (w x h x d) 235 x 230 x 336	Unit height: N/A