

An Essential Way of Delivering Dynamic Content

SE3KE

Managing informative or promotional content becomes simpler with the SE3KE series. This cost-effective display satisfies a wide range of display purposes in your business while reducing operational costs with low power consumption. Easy-to-use menus designed for business purposes make for a more convenient and powerful display.



An Essential Way of Delivering Dynamic Content

SE3KE

Simple Content Management

User-Friendly Menu for Digital Signage

With the signage dedicated home menu, users can check key information related to displays at a glance. On the bottom, the content management menu is provided, letting you explore and play available content and set playlists with desired schedules using a remote controller.

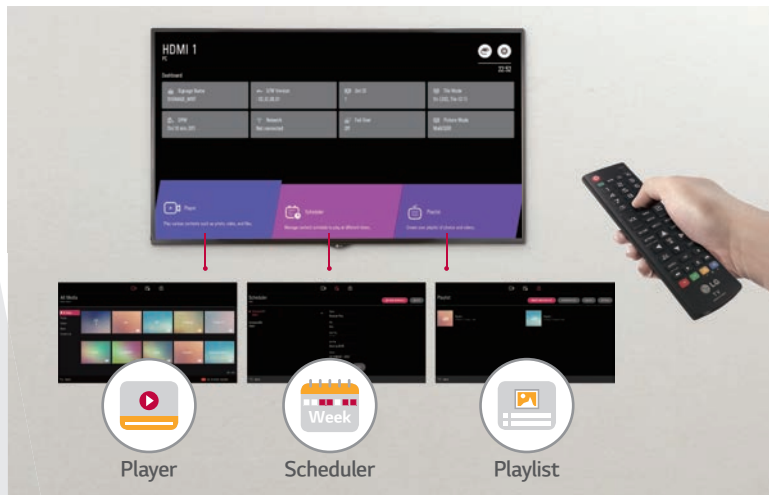

USB Content Scheduling & Data Cloning

USB content scheduling and cloning makes managing multiple displays more efficient for optimal content playback and operation, since users don't have to set up each display one by one. Once users copy data to a USB in one display, it will be easily distributed to others through a USB plug-in.

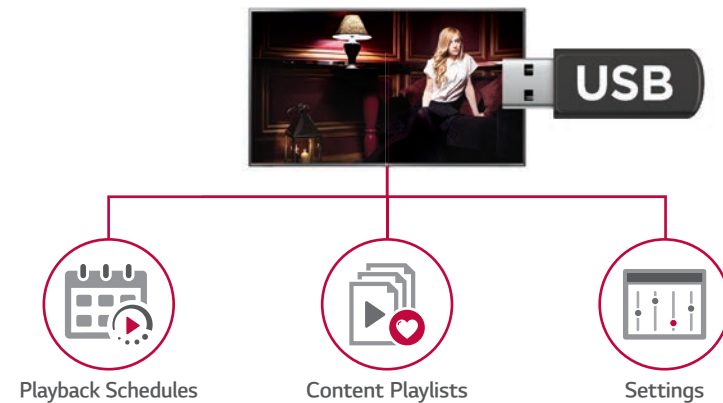

An Essential Way of Delivering Dynamic Content

SE3KE

Efficient Operation

Stand-by Screen Mode

The SE3KE series ensures low power consumption by preventing unnecessary power usage using the PM (Power Management) mode. It partially keeps power-on status controllable by network while the screen is turned off, enabling efficient power management.

Scheduled Screen Wash

ISM (Image Sticking Minimization) mode supports users in setting up periods and times to refresh the screen using prestored color bars or customized images. It offers a better visual experience to viewers by preventing the occurrence of image sticking.

18/7 Operation

The SE3KE series can be operated for 18 hours a day, which provides users with the flexibility to allocate and operate it in places that are open for long periods of time.

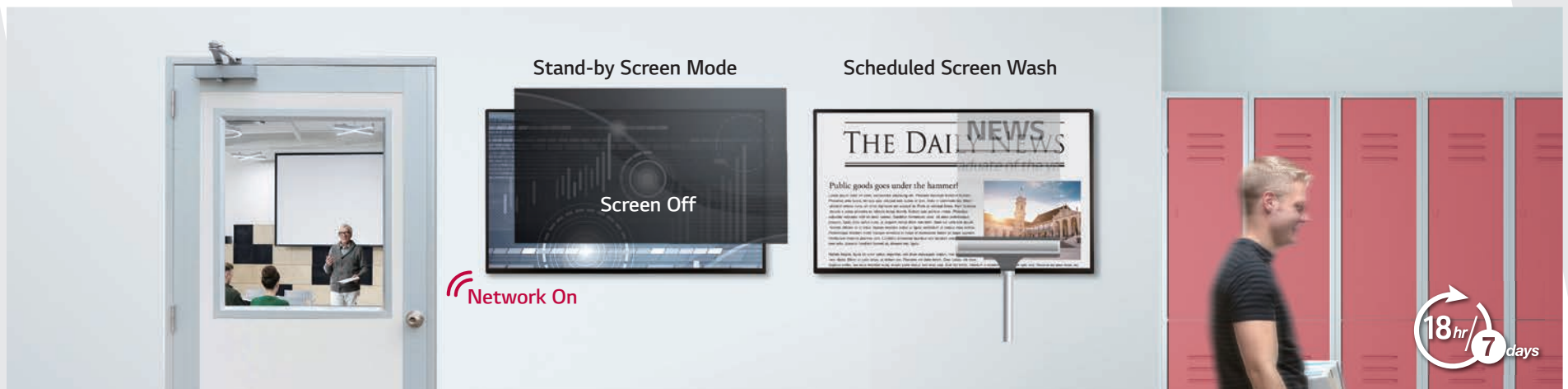

An Essential Way of Delivering Dynamic Content

SE3KE

Excellent Connectivity

A Wide Range of Interfaces

Thanks to its high compatibility with diverse interfaces, users can select among various input/output sources for optimal content playback and control.

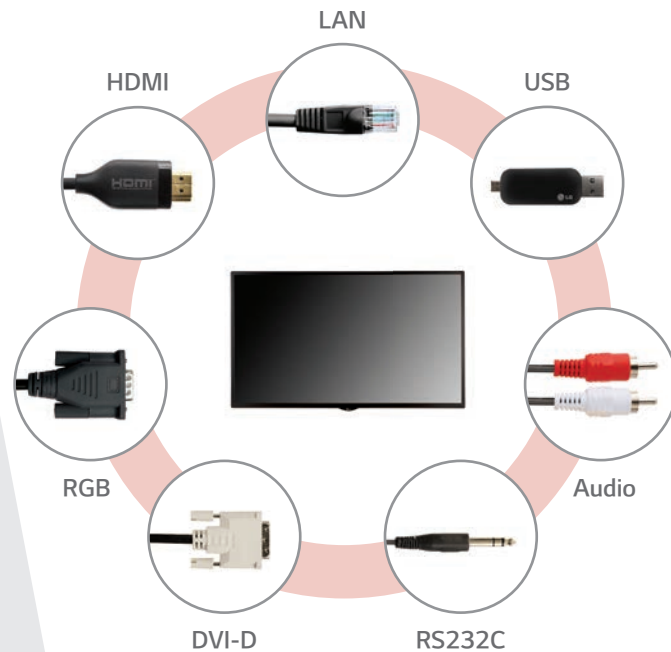

Compatibility with AV Control Systems

The SE3KE series has been certified Crestron Connected® for a higher level of compatibility with professional AV controls to achieve seamless integration and automated control*, boosting business management efficiency.



* Network based control

An Essential Way of Delivering Dynamic Content

SE3KE

Industrial Design

Detachable Logo & Built-in Speaker

The detachable logo makes it easy for the user to arrange the signage. Also, sounds can be played from built-in speakers, offering viewers various multi-media experiences.

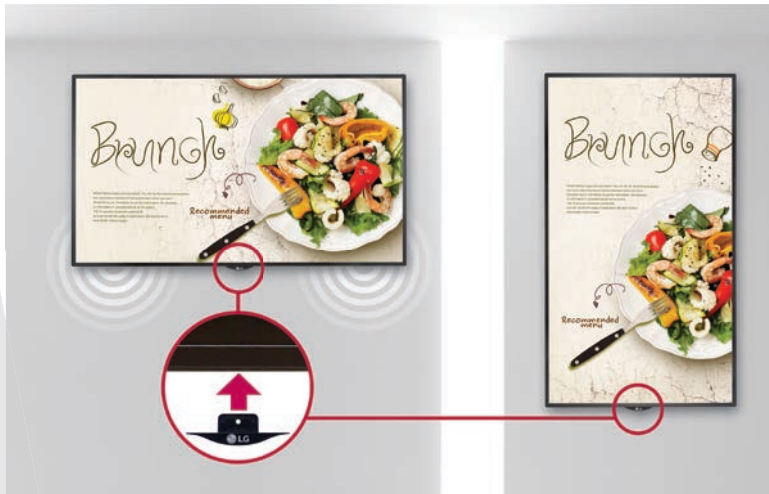

Conformal Coating

The product can be often unavoidably exposed to dust and water during maintenance. Conformal coating on major circuit board eliminates such circumstances by protecting it against dust, iron powder, humidity, etc.



Dimension (Unit: mm)

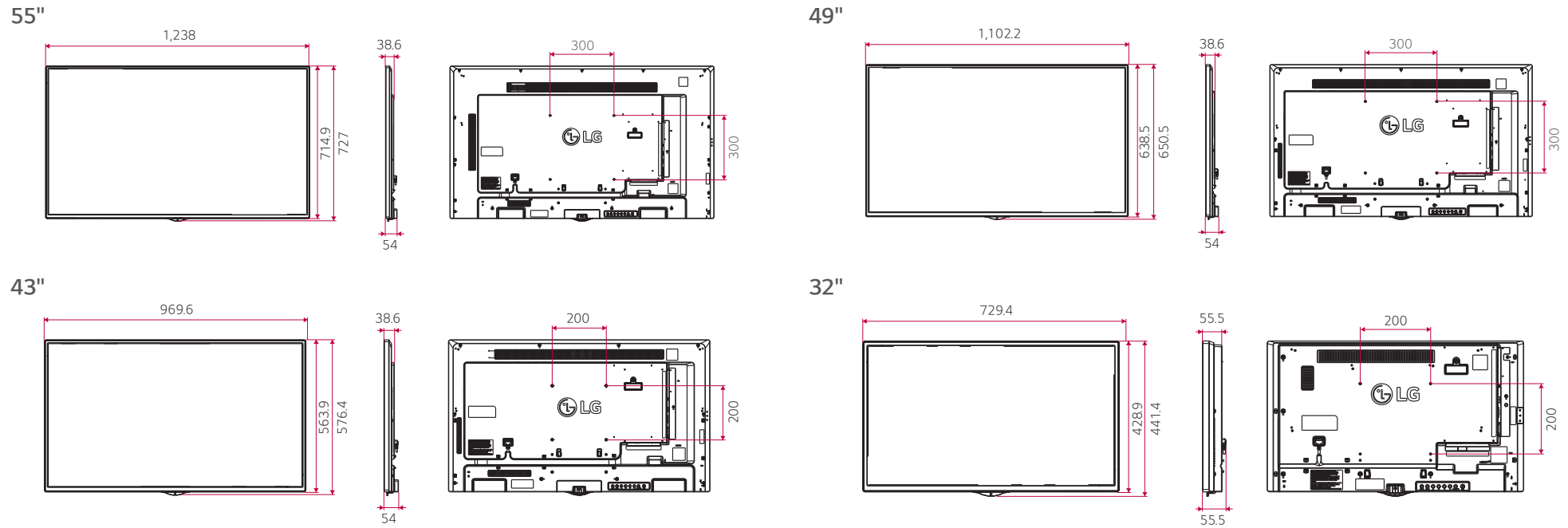

Connectivity

55" / 49" / 43" / 32"

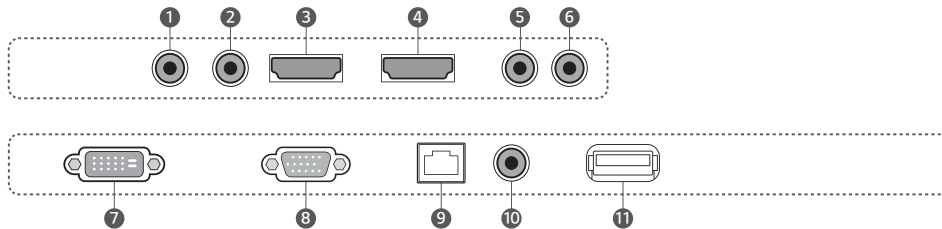

- | | | |
|---------------|-------------|------------|
| ① RS-232C IN | ⑤ AUDIO OUT | ⑨ LAN |
| ② RS-232C OUT | ⑥ EXT IR IN | ⑩ AUDIO IN |
| ③ HDMI IN 1 | ⑦ DVI-D IN | ⑪ USB |
| ④ HDMI IN 2 | ⑧ RGB IN | |

Specifications

	55SE3KE	49SE3KE	43SE3KE	32SE3KE	
PANEL	Screen Size	55"	49"	43"	32"
	Panel Technology	IPS	IPS	IPS	IPS
	Aspect Ratio	16 : 9	16 : 9	16 : 9	16 : 9
	Native Resolution	1,920 x 1,080 (FHD)	1,920 x 1,080 (FHD)	1,920 x 1,080 (FHD)	1,920 x 1,080 (FHD)
	Brightness (Typ.)	350 cd/m ²	350 cd/m ²	350 cd/m ²	350 cd/m ²
	Contrast Ratio	1,100:1	1,100:1	1,100:1	1,100:1
	Viewing Angle (H x V)	178 x 178	178 x 178	178 x 178	178 x 178
	Response Time	12 ms (G to G BW), 9.0 ms (WOT)	12 ms (G to G BW), 10.1 ms (WOT)	12 ms (G to G BW), 9.4 ms (WOT)	10 ms (G to G BW), 7.1 ms (WOT)
	Surface Treatment (Haze)	AGP Haze 1%	AGP Haze 1%	AGP Haze 1%	AGP Haze 1%
	Life Time (Typ.)	50,000 Hrs	50,000 Hrs	50,000 Hrs	50,000 Hrs
Guaranteed Operating Hours	18 Hrs	18 Hrs	18 Hrs	18 Hrs	
Orientation	Landscape & Portrait	Landscape & Portrait	Landscape & Portrait	Landscape & Portrait	
CONNECTIVITY	Input	HDMI (2), DVI-D, RGB, Audio, USB	HDMI (2), DVI-D, RGB, Audio, USB	HDMI (2), DVI-D, RGB, Audio, USB	HDMI (2), DVI-D, RGB, Audio, USB
	Output	Audio (Off/Fixed/Variable)	Audio (Off/Fixed/Variable)	Audio (Off/Fixed/Variable)	Audio (Off/Fixed/Variable)
	External Control	RS232C In/out, RJ45 In, IR In	RS232C In/out, RJ45 In, IR In	RS232C In/out, RJ45 In, IR In	RS232C In/out, RJ45 In, IR In
MECHANICAL SPECIFICATION	Bezel Color	Black	Black	Black	Black
	Bezel Width	11.9 mm (T/R/L), 18 mm (B)	11.9 mm (T/R/L), 18 mm (B)	11.9 mm (T/R/L), 18 mm (B)	13 mm (T/R/L), 18 mm (B)
	Monitor Dimension (W x H x D)	1,238 x 714.9 x 54 mm	1,102.2 x 638.5 x 54 mm	969.6 x 563.9 x 54 mm	729.4 x 428.9 x 55.5 mm
	Weight (Head)	17.5 kg	14.3 kg	10.0 kg	5.4 kg
	Monitor with Optional Stand Dimensions (W x H x D)	1,238 x 773.4 x 219.6 mm	1,102.2 x 696.8 x 219.6 mm	969.6 x 622.2 x 193 mm	729.4 x 481 x 154.2 mm
	Weight (Head+Stand)	20.8 kg	17.6 kg	12.5 kg	6.2 kg
	Carton Dimensions (W x H x D)	1,330 x 807 x 170 mm	1,197 x 760 x 166 mm	1,052 x 650 x 123 mm	810 x 510 x 132 mm
	Packed Weight	21.7 kg	17.4 kg	12.6 kg	6.7 kg
VESA™ Standard Mount Interface	300 x 300 mm	300 x 300 mm	200 x 200 mm	200 x 200 mm	
KEY FEATURE	Wi-Fi Dongle Ready, Temperature Sensor, Local Key Operation, USB Auto Playback, Local Contents Scheduling, Fail Over, Image Customization (Booting Logo/No Signal), Content Sync. (RS232C/Local Network), SNMP (ver.2), ISM Mode, Crestron Connected ⁽⁸⁾ , DPM, PM Mode, Wake on LAN, Smart Energy Saving, HDMI-CEC ²⁾				
ENVIRONMENTAL CONDITIONS	Operation Temperature	0°C to 40°C	0°C to 40°C	0°C to 40°C	0°C to 40°C
	Operation Humidity	10% to 80%	10% to 80%	10% to 80%	10% to 80%
POWER	Power Supply	100-240V~, 50/60Hz	100-240V~, 50/60Hz	100-240V~, 50/60Hz	100-240V~, 50/60Hz
	Power Type	Built-In Power	Built-In Power	Built-In Power	Built-In Power
	Power Typ. / Max.	65 W / 100 W	60 W / 95 W	55 W / 90 W	45 W / 80 W
	Consumption Smart Energy Saving	45.5 W	42 W	38.5 W	31.5 W
SOUND	Speaker	20 W (10 W x 2)	20 W (10 W x 2)	20 W (10 W x 2)	20 W (10 W x 2)
	Safety	IEC 60950-1 / EN 60950-1 / UL 60950-1	IEC 60950-1 / EN 60950-1 / UL 60950-1	IEC 60950-1 / EN 60950-1 / UL 60950-1	IEC 60950-1 / EN 60950-1 / UL 60950-1
CERTIFICATION	EMC	FCC Class "A" / CE / KC	FCC Class "A" / CE / KC	FCC Class "A" / CE / KC	FCC Class "A" / CE / KC
	ErP / Energy Star	Yes ³⁾ / Yes (Energy Star 7.0)	Yes ³⁾ / Yes (Energy Star 7.0)	Yes ³⁾ / Yes (Energy Star 7.0)	Yes ³⁾ / Yes (Energy Star 7.0)
MEDIA PLAYER COMPATIBILITY	OPS Type Compatible	Yes	Yes	Yes	Yes
SOFTWARE COMPATIBILITY⁴⁾	External Media Player Attachable	Yes (MP500 / MP700)	Yes (MP500 / MP700)	Yes (MP500 / MP700)	Yes (MP500 / MP700)
	Content Management Software	SuperSign CMS	SuperSign CMS	SuperSign CMS	SuperSign CMS
	Control and Monitoring Software	SuperSign Control / Control+	SuperSign Control / Control+	SuperSign Control / Control+	SuperSign Control / Control+
ACCESSORIES	Basic	Remote Controller, Power Cord, QSG, RGB Cable, Regulation Book, Phone to RS232C Gender, IR Receiver	Remote Controller, Power Cord, QSG, RGB Cable, Regulation Book, Phone to RS232C Gender, IR Receiver	Remote Controller, Power Cord, QSG, RGB Cable, Regulation Book, Phone to RS232C Gender, IR Receiver	Remote Controller, Power Cord, QSG, RGB Cable, Regulation Book, Phone to RS232C Gender, IR Receiver
	Optional	Stand (ST-492T), Media Player, Wall Bracket (LSW350B), VESA Adapter (AM-B330S), Wi-Fi Dongle (AN-WF500), Touch Overlay (KT-T55E)	Stand (ST-492T), Media Player, Wall Bracket (LSW350B), VESA Adapter (AM-B330S), Wi-Fi Dongle (AN-WF500), Touch Overlay (KT-T49E)	Stand (ST-432T), Media Player, Wall Bracket (LSW230B), VESA Adapter (AM-B220S), Wi-Fi Dongle (AN-WF500), Touch Overlay (KT-T43E)	Stand (ST-322T), Media Player, Wall Bracket (LSW230B), VESA Adapter (AM-B220S), Wi-Fi Dongle (AN-WF500), Touch Overlay (KT-T32E)

1) Network Based Control 2) Compatibility may differ by equipment. 3) ErP: N/A for EU 4) Software compatibility may change over time. Please contact LG sales representative for details.



Download
LG C-Display+
Mobile App

Google Play Store

- www.lg.com/b2b
- www.youtube.com/c/LGCommercialDisplay
- www.facebook.com/LGInformationDisplay
- www.linkedin.com/company/LGInformationDisplay

LG may make changes to specifications and product descriptions without notice.
Copyright © 2018 LG Electronics Inc. All rights reserved. "LG Life's Good" is a registered trademark of LG Corp.
The names of products and brands mentioned here may be the trademarks of their respective owners.

