



# VEXO115A

## 15" high performance 2-way active loudspeaker

### Highlights:

- Compatible with AUDAC Touch™
- Compatible with TouchLink™
- Dante™/AES67 expansion port
- Advanced DSP and loudspeaker management
- Powerful sound experience
- High sound pressure levels with tight driver response
- Modern & elegant design
- DuraCoat™ texture paintwork
- Impact resistant
- Horizontal and vertical mounting
- WaveDynamics™ supported

### Product information:

The VEXO1xx series are compact high performance 2-way loudspeakers and come in 4 different (active or passive) models. The low-frequency transducer, which is made out of high-quality materials, is combined with a 1.4 (VEXO108) or 1.7" (VEXO110, VEXO112 & VEXO115) voice coil compression driver, enabling high sound pressure levels and a tight driver response with a rotatable 90° x 70° coverage pattern for a wide range of applications.

Thanks to the unique driver composition, the VEXO115A delivers a clear and natural sound with an RMS power of 500 Watts and a maximum power of 2000 Watt. The frequency response ( $\pm 3\text{dB}$ ) starts from 50Hz up to 20 kHz and the sensitivity (1W/1m) reaches 100dB while a maximum continuous sound pressure level from 127dB can be achieved. When not in use, the active versions of the VEXO series devices automatically go into an energy-saving standby mode. This means that active versions can also be used in fixed installations, as there is no need to physically shut them down after each use.

The construction of the cabinets is made of 15 mm plywood with a polyurethane coating, making them resistant to any impact. The front side of the cabinet is finished with a powder-coated steel grill with acoustical foam. A recessed carry handle on the rear side makes carrying easy. Positioning and suspension of the speaker are easily achieved by using the standard 35 mm pole adapter on the bottom and the M10 rigging points. Two speaker connectors provide reliable connections with easy link-through to cabinets.

The optional Clever U bracket allows mounting the high power 2-way cabinet both horizontally and vertically. An inclination of -90° to +35° ensures an optimal positioning. The optional MBK bracket even allows mounting the VEXO series to the ceiling which gives the opportunity to install the loudspeaker cleanly in any environment.

By installing the optional ANI44XT Dante™ audio network interface in the active loudspeaker, the VEXO series can be integrated into any Dante enabled AV network and transfer digital audio with any compatible solution on the market.

When the ANI44XT is installed the VEXO series will be compatible with AUDAC Touch™ and TouchLink™. Used for creating virtual zones by linking multiple compatible devices with each other. In AUDAC Touch™ you can select multiple amplifier channels that should react to the user as one zone.



### Certification:



The VEXO115A features the unique WaveDynamics™ innovation. Due to this DSP processor, the audio control and processing technology enable any user to effortless control the most advanced acoustic configurations.

The integrated DSP allows pre-sets for full-range, satellite and custom configurations and can be loaded via the USB slot on the back of the device. The AUDAC Touch™ application allows to equalize and create personalised presets and control the equipped VEXO loudspeakers. When installing the ANI44XT, all personalised presets and settings can be adjusted from anywhere at any time.

## Impedance:

---

$\Omega$  8 Ohm

## Applications:

---

- Bars & Restaurants
- Education
- Sporting facilities
- Clubs
- Concert venues
- Events

## System specifications:

Speaker type			2-way
Peak power handling			2000 W
Program power handling			1000 W
RMS/AES power handling			500 W
Impedance			8 $\Omega$
Sensitivity (1W/1m)			100 dB
Sound Pressure (Max. W/1m)			127 dB
Frequency	Response ( $\pm$ 3 dB)	50 Hz - 20 kHz	
Crossover	Type	Active	
Dispersion	Horizontal	90°	
	Vertical	70°	
Drivers	HF	Compression driver with 1.7" VC and 1" throat	
	LF	15" (3" VC)	
Connectors	Remote control	RJ45	
	Input	2 x Combo XLR / 6.3 mm jack	
		3-pin Euro Terminal Block (Pitch - 3.81 mm)	
		3-Pin terminal block (linkthrough)	
		XLR male (linkthrough)	
Inputs			USB port
			RJ45 (Ethernet)
Power	Consumption	Standby	3.2 W
		Idle	22.5 W
AC Inputs	Voltage	110 ~ 240 V AC / 50 ~ 60 Hz	

## Product Features:

---

Dimensions		429 x 690 x 450 mm (W x H x D)
Weight		28.3 kg
Construction		15 mm high-quality plywood
Finish	Cabinet finishing	Polyurethane coating
Front finish		Powder coated steel grill with acoustical foam
Mounting & handling	Rigging points	10 x M10
	Stand fitting	35 mm pole adapter on bottom
	Carry handles	On top
Accessories	Optional	ANI44XT - Dante™/AES67 audio network interface
Powerdrive mount		Powerdrive type 100 (127 x 70 mm)
Colours		Black & White
Accessories	Optional	MBK115V Mounting bracket

## Variants:

---

- VEXO115A/B - Black version
- VEXO115A/W - White version

## Architects' and Engineers' Specifications:

---

The loudspeaker cabinet must be an active 15" 2-way system. The cabinet must be constructed of 15 mm high-quality plywood with a durable impact proof Polyurethane coating. The front side must be finished with a powder coated steel grill which is lined with an acoustical foam. The cabinet must have a recessed carry handle on the rear side of the cabinet for easy handling, while a standard 35 mm pole adapter and 10 x M10 rigging points must be provided for positioning and suspension of the speaker. The loudspeaker cabinet must have an RMS power handling of 500 Watt with a maximum power handling of 2000 Watt. The frequency response ( $\pm 3$  dB) must range from 50 Hz to 20 kHz. The sensitivity must be 100 dB when measuring with an input signal of 1 Watt at a distance of 1 meter, while the maximum continuous sound pressure level must reach 127 dB. The loudspeaker must consist of a HF compression driver with 1.7" VC and 1" throat and a 15" low frequency loudspeaker. It must have an impedance of 8 Ohm. The complete model is constructed of high-quality components. It must also have an integrated tweeter overload protection circuit. The horn mounted on the HF driver must have a horizontal dispersion of 90° and a vertical dispersion of 70° and must be rotatable, allowing both horizontal and vertical use. The signal input is implemented both balanced and unbalanced. The unbalanced line input shall be implemented through two combo XLR/ 6.3mm jack connections while the balanced input is implemented through two 3-pin terminal block connectors. A passive speaker is connected to the speaker through 3-pin terminal block or XLR connections. LINE or MIC input signal will be selectable by two buttons and gain equalization shall be adjustable using controls on the rear side of the unit. The loudspeaker must contain the WaveDynamics™ innovation. The HF-amplifier shall be a class-AB amplifier and the LF-amplifier shall be a class-D amplifier both with DSP processor which enables the function to choose between acoustical modes. The different modes may be selected with a button on the back of the device. Custom modes must be uploadable with a USB-drive true the USB-port. The power supply shall be a switching mode type with operation over a wide voltage range from 100 ~ 240 V AC 50/60 Hz which makes it globally deployable. When not in use, the device must go in a energy-saving standby mode. The loudspeaker cabinet must not exceed a width of 429 mm, a height of 690 mm and a depth of 450 mm. Its weight must not exceed 28.3 kg. Additionally, a RJ45 connector could be implemented when an ANI44XT is installed. By this allowing the integration into any Dante enabled AV network and transfer digital audio with any compatible device.

# Acoustical data graphs:

## Horizontal Polars:

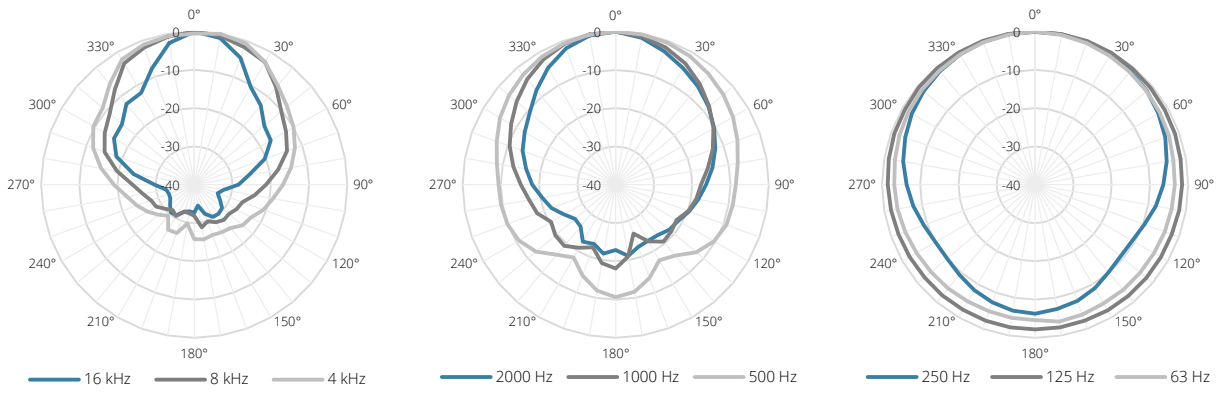

## Vertical Polars:

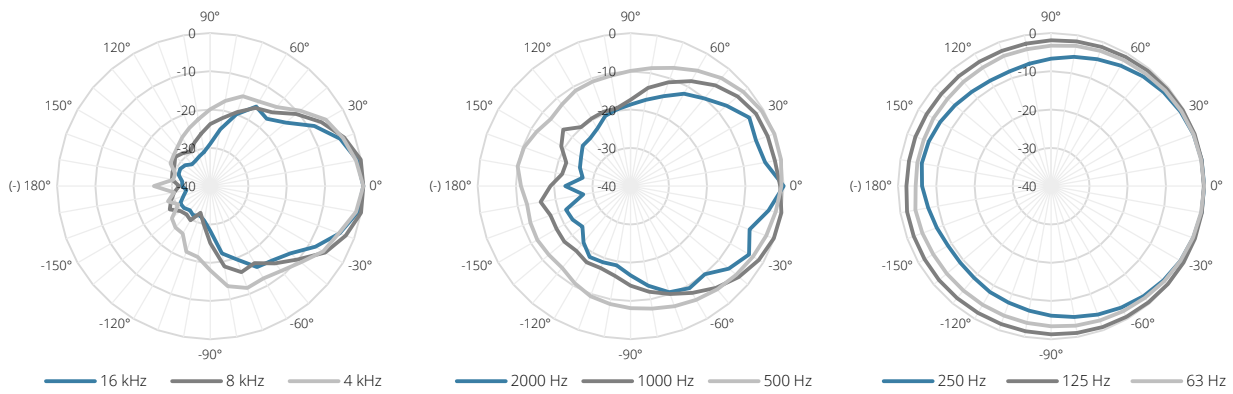

## Sensitivity:

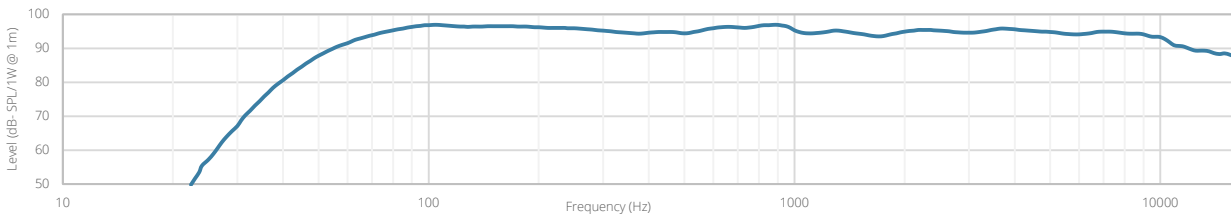

## Beamwidth (-3dB):

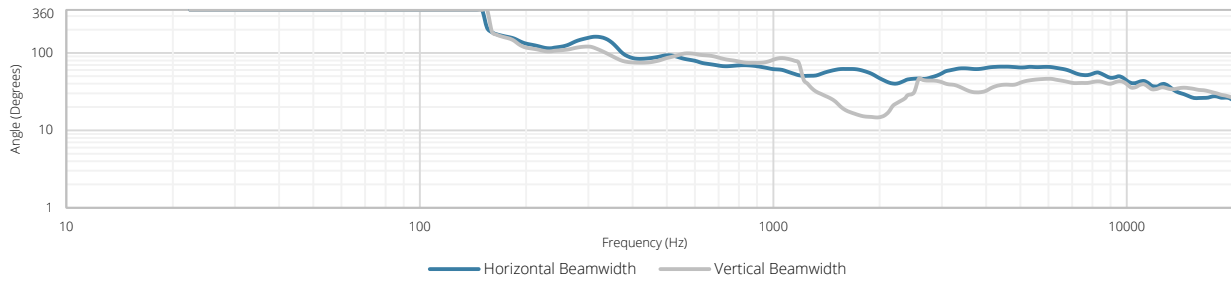

## Directivity index:

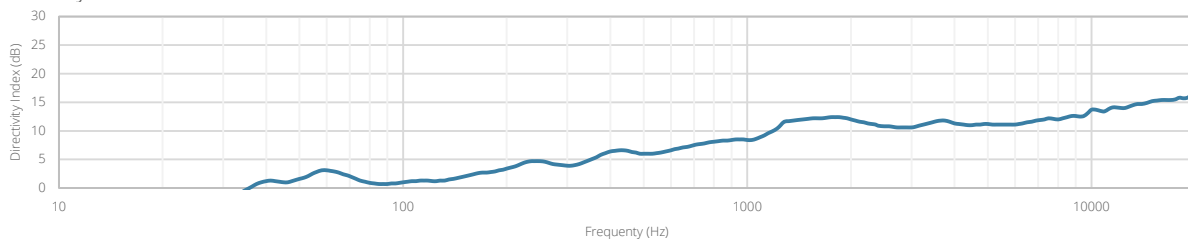

**AUDAC-VEXO115(A)**

2-Way 15" active speaker cabinet

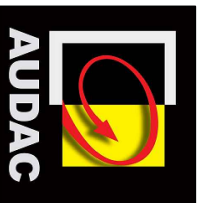
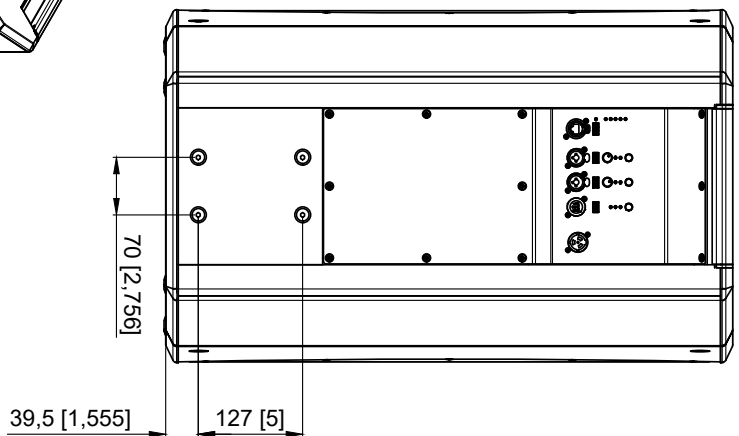
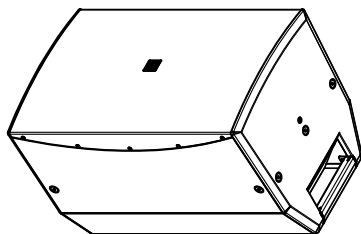
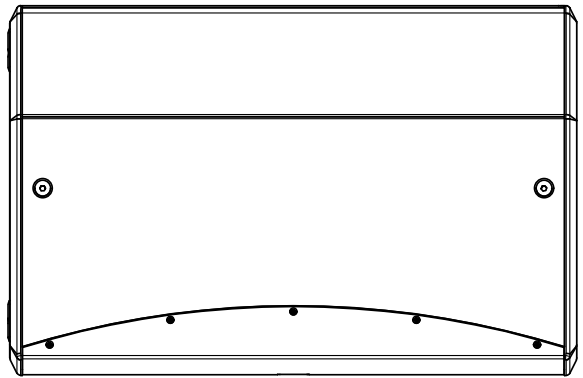
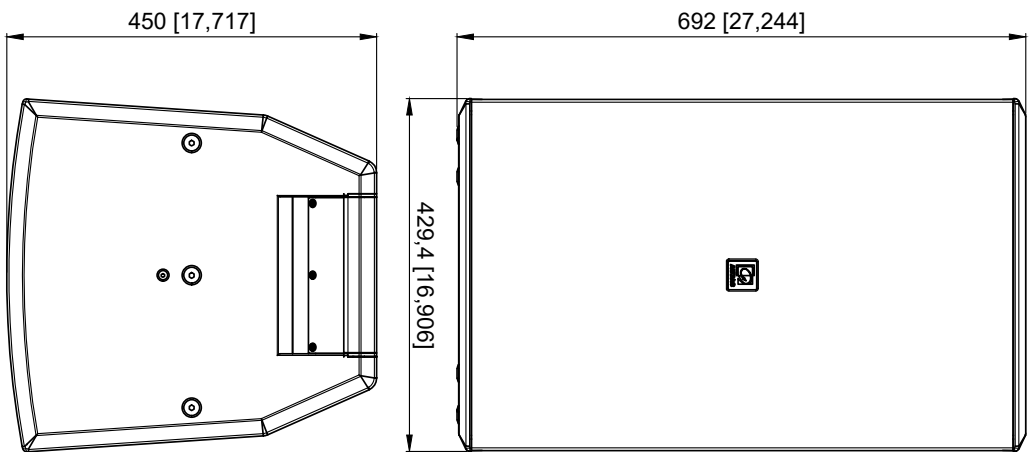

<b>VEXO115A</b>		<b>Product description</b>	
ACTIVE HIGH PERFORMANCE LOUDSPEAKER - 15"/2WAY - 500W RMS			
<b>MM</b> [INCH]	<b>Weight</b>	<b>Outer dimensions</b> (w x h x d)	<b>Unit height</b>
28,9 Kg 63,7 lbs	429 x 692 x 450 mm 16,906 x 27,244 x 17,717 "	N/A	